

Dealer's Manual

ROAD	GRAVEL	MTB
E-BIKE	LIFESTYLE	GENERAL

ALFINE / NEXUS

ALFINE

SG-S7001-11

SG-S7001-8

NEXUS

SG-C6001-8

SG-C6011-8

SG-C7000-5

SG-C7002-5

Contents

IMPORTANT NOTICE	3
TO ENSURE SAFETY	4
List of tools to be used	12
Installation/removal	13
Installing the sprocket (without chain guard)	13
Installing the sprocket (with chain guard)	14
Installation of the cassette joint to the hub.....	15
Installing the disc brake rotor	16
• CENTER LOCK type	16
• 5 screw type (with lock washers)	16
Installing the INTER M brake to the hub body	18
Installation of the hub to the frame.....	19
Installation of the shifting cable	23
• Shift lever side	23
• Cassette joint side	23
Adjustment	28
Adjusting the cassette joint.....	28
Maintenance	30
Disconnecting the shifting cable when removing the rear wheel from the frame.....	30
Oil maintenance of the internal assembly	31
• For internal 8-speed (oil maintenance kit: Y00298010)	31
• For internal 11-speed (oil maintenance kit: Y13098023)	33

IMPORTANT NOTICE

- **This dealer's manual is intended primarily for use by professional bicycle mechanics.**

Users who are not professionally trained for bicycle assembly should not attempt to install the components themselves using the dealer's manuals.



If any part of the information on the manual is unclear to you, do not proceed with the installation. Instead, contact your place of purchase or a distributor for assistance.

- Make sure to read all manuals included with each product.
- Do not disassemble or modify the product other than as stated in the information contained in this dealer's manual.
- All manuals and technical documents are accessible online at <https://si.shimano.com>.
- For consumers who do not have easy access to the internet, please contact a SHIMANO distributor or any of the SHIMANO offices to obtain a hardcopy of the user's manual.
- Please observe the appropriate rules and regulations of the country, state or region in which you conduct your business as a dealer.

For safety, be sure to read this dealer's manual thoroughly before use, and follow it for correct use.

The following instructions must be observed at all times in order to prevent personal injury and physical damage to equipment and surroundings.

The instructions are classified according to the degree of danger or damage which may occur if the product is used incorrectly.

 DANGER	Failure to follow the instructions will result in death or serious injury.
 WARNING	Failure to follow the instructions could result in death or serious injury.
 CAUTION	Failure to follow the instructions could cause personal injury or physical damage to equipment and surroundings.

TO ENSURE SAFETY

⚠ WARNING

- **Be sure to follow the instructions provided in the manuals when installing the product.**
Only use SHIMANO genuine parts. If a component or replacement part is incorrectly assembled or adjusted, it can lead to component failure and cause the rider to lose control and crash.
-  Wear approved eye protection while performing maintenance tasks such as replacing components.

Be sure to also inform users of the following:

- Because each bicycle may handle slightly differently depending on the model, be sure to learn the proper braking technique (including brake lever pressure and bicycle control characteristics) and operation of your bicycle. Improper use of your bicycle's brake system may result in a loss of control, which could lead to serious injury due to a fall or collision.
- Check that the wheels are fastened securely before riding the bicycle. You may fall or collide and be seriously injured.

■ Brake

- Do not apply the front brake too strongly. If you do so, the front wheel may lock and the bicycle may fall forward, and serious injury may result.
- Because the required braking distance will be longer during wet weather, reduce your speed and apply the brakes early and gently. You may fall or collide and be seriously injured.
- A wet road surface may cause tires to lose traction; therefore, to avoid this, reduce your speed and apply the brakes early and gently. If the tires lose traction, you may fall and be seriously injured.

■ Disc brake rotor

- Keep your fingers away from rotating disc brake rotors. The disc brake rotor is sharp enough to inflict severe injury to your fingers if caught within the openings of moving rotor.



- Do not touch the calipers or disc brake rotor while riding or immediately after dismounting from the bicycle. The calipers and disc brake rotor will become hot when the brakes are operated, so you may get burned if you touch them.
- Do not allow any oil or grease to get onto the disc brake rotor and brake pads. Riding the bicycle with oil or grease on the disc brake rotor and brake pads may prevent the brakes from operating and result in serious injury due to a fall or collision.
- Check the thickness of the brake pads and do not use them if they have a thickness of 0.5 mm or less. Doing so may prevent the brakes from operating and result in serious injury.

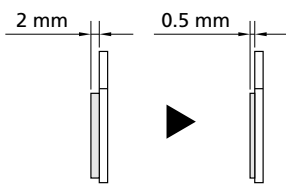

- Do not use the disc brake rotor if it is cracked or deformed. The disc brake rotor may break, and result in serious injury due to a fall.

TO ENSURE SAFETY

- Do not use the disc brake rotor if its thickness is 1.5 mm or less. Also do not use it if the aluminum surface becomes visible. The disc brake rotor may break, and result in serious injury due to a fall.
- Coaster brake hub
- When using a reversed rear dropout, use a chain adjuster to remove excess slack from the chain.

For installation to the bicycle and maintenance

- For information on products that can be installed, check the compatibility information (<https://productinfo.shimano.com>).
- When securing the brake arm to the frame, be sure to use an arm clip that matches the size of the chainstay, and securely tighten them with the clip bolt and clip nut to the specified tightening torque.
Use a lock nut with nylon insert (self-locking nut) as the clip nut. It is recommended that SHIMANO made clip bolts, clip nuts, and arm clips be used.
If the clip nut comes off the brake arm, or if the clip bolt or arm clip becomes damaged, the brake arm may rotate on the chainstay and cause the handlebars to jerk suddenly, or the bicycle wheel may lock and result in serious injury due to a fall or collision.
- When installing the hub to the frame, be sure to install the correct non-turn washers to the left and right sides, and securely tighten the hub nuts to the specified torques. If the non-turn washers are installed on one side only, or if the hub nuts are not tightened sufficiently, the non-turn washer may fall out, which could cause the hub axle to rotate and the cassette joint to turn, resulting in the handlebars being accidentally pulled by the gear shifting cable and an extremely serious accident.
- Assemble the wheel with 3x or 4x lacing, and do not spoke the wheel radially.
Otherwise, the spokes or the wheel may get damaged, or noise may occur when braking.

< CT-S500 / CT-S510 >

- Never use alkali- or acid-based solvents such as rust cleaners. If those solvents are used the chain might break and cause serious injury.
- Clean the chain with an appropriate chain cleaner regularly. Intervals between maintenance depend on the use and riding circumstances.
- Use the reinforced connecting pin only for connecting the narrow-type chain. If connecting pins other than reinforced connecting pins are used, or if a reinforced connecting pin or tool which is not suitable for that type of chain is used, sufficient connection force may not be obtained, which could cause the chain to break or skip.
- If it is necessary to readjust the length of the chain due to a change in the number of sprocket teeth, make the cut at some other place than the place where the chain has been joined using a reinforced connecting pin or an end pin.

The chain will be damaged if it is cut at a place where it has been joined with a reinforced connecting pin or an end pin.

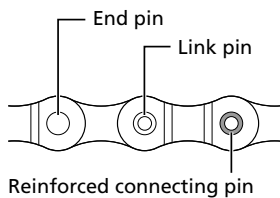

- Check that the tension of the chain is correct and that the chain is not damaged. If the tension is too weak or the chain is damaged, the chain should be replaced. If this is not done, the chain may break and cause serious injury.

⚠ CAUTION

Be sure to also inform users of the following:

- Shift the shift lever one or two gears at a time. During shifting, reduce the pedal pressure. If you try to force operation of the shift lever or suddenly shift three or more gears while the pedals are being turned strongly, your feet may come off the pedals and the bicycle may fall over, which could result in serious injury.
Operating the shift lever to multi-shift to a light gear may also cause the outer casing to spring out of the shift lever. This does not affect the capabilities of the shifter because the outer casing returns to the original position after shifting.
- Disc brake type
 - Do not touch the calipers or disc brake rotor while riding or immediately after dismounting from the bicycle. The calipers and disc brake rotor will become hot when the brakes are operated, so you may get burned if you touch them.
 - Disc brakes have a bed-in period, and the braking force will gradually increase as the bed-in period progresses. Accidents or falls may occur due to losing control of the bicycle, possibly resulting in serious injury. The same thing will happen when the brake pads or disc brake rotor are replaced.
- Coaster brake type
 - Do not touch the coaster brake while riding or immediately after dismounting from the bicycle. The coaster brake will become hot when the brakes are operated, so you may get burned if you touch them.
 - Do not continuously apply the brakes when riding down long slopes. This will cause the internal brake parts to become very hot, weakening braking performance, as well as causing a reduction in the amount of brake grease inside the brake, which can lead to problems such as abnormally sudden braking.
 - Perform the bed-in procedure and check that the braking force of the coaster brake is correct.
- Roller brake type
 - When the brake is used frequently, do not touch the area around the brake for at least 30 minutes after riding the bicycle. The area around the brake may become hot.

Area around the brake

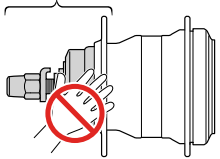

- Do not continuously apply the brakes when riding down long slopes. This will cause the internal brake parts to become very hot, weakening braking performance, as well as causing a reduction in the amount of brake grease inside the brake, which can lead to problems such as abnormally sudden braking.
- The brake unit and front hub unit should never be disassembled. If it is disassembled, it may no longer work properly.

NOTICE

Be sure to also inform users of the following:

- The gears can be shifted while lightly pedaling, but on rare occasions the pawls and ratchet inside the hub may produce some noise afterwards as part of normal gear shifting operation. In addition, a loud sound may be temporarily emitted if the gears are shifted while strongly pedaling with E-BIKE, etc., but this is normal.

- The internal geared hub is not completely waterproof. Avoid using the hub in places where water might get inside and do not use high-pressure jets of water to clean the hub, otherwise the internal mechanism may rust.
- The following phenomena occur due to the internal gear-shifting structure and are not a failure of the internal components.

Phenomenon	Hub type		Gear position
	For coaster brake	For roller brake, disc brake, or V-BRAKE	
A sound is emitted when the pedal turns.	X	-	All speeds other than 1-speed
A sound is emitted when the bicycle is pushed back.	X	X	Internal 11-speed: 7-speed to 11-speed Internal 8-speed: 5-speed to 8-speed Internal 5-speed: All speeds other than 1-speed
There is a built-in mechanism for facilitating gear shifting and when the mechanism operates during gear shifting, noise and vibrations are generated.	X	X	All speeds
Depending on the gear position, gear shifting may give different feels.	X	X	All speeds
Sound is emitted when pedal rotation is stopped while riding.	X	-	All speeds

- Products are not guaranteed against natural wear and deterioration from normal use and aging.
- For maximum performance we highly recommend SHIMANO lubricants and maintenance products.

■ Coaster brake type

- If the wheels are not rotating smoothly, you need to replace or grease the brake shoes.

For installation to the bicycle and maintenance

- The cassette joint should only be used with sprockets with 16T to 23T.
- The following chainring and sprocket settings are recommended.

11-speed (recommended sprocket ratio: 1.8 to 2.0)

FC-S501 number of teeth	45	42	39
SM-GEAR	14	-	-
	15	-	-
	16	-	-
	17	-	-
	18	-	-
	19	-	-

FC-S501 number of teeth		45	42	39
	20	-	-	X
	21	-	X	X
	22	-	X	-
	23	X	X	-
CS-S500	18	-	-	-
	20	-	-	-

8-speed (recommended sprocket ratio: 2.0 to 2.25)

FC-S501 number of teeth		45	42	39
SM-GEAR	14	-	-	-
	15	-	-	-
	16	-	-	-
	17	-	-	-
	18	-	-	X
	19	-	X	X
	20	X	X	-
	21	X	X	-
	22	X	-	-
	23	-	-	-
CS-S500	18	-	-	X
	20	X	X	-

5-speed (refer to the table below for the usable combinations of chainrings and sprockets)

Wheel diameter		24 inch			26 inch		
CS-C7000 number of teeth		30	27	24	30	27	24
Chainring number of teeth	30	-	-	-	-	-	-
	31	-	-	X	-	-	X
	32	-	-	X	-	-	X
	33	-	-	X	-	-	X
	34	-	-	X	-	-	X
	35	-	X	X	-	X	X
	36	-	X	X	-	X	X
	37	-	X	X	-	X	X*
	38	X	X	X	X	X	X*

Wheel diameter	24 inch			26 inch		
CS-C7000 number of teeth	30	27	24	30	27	24
39	X	X	X	X	X	-
40	X	X	X*	X	X	-
41	X	X	X*	X	X	-
42	X	X	X*	X	X*	-
43	X	X	-	X	X*	-
44	X	X	-	X	-	-
45	X	X*	-	X	-	-

Wheel diameter	27 inch			700C		
CS-C7000 number of teeth	30	27	24	30	27	24
Chaining number of teeth	30	-	-	-	-	-
	31	-	-	X	-	X
	32	-	-	X	-	X
	33	-	-	X	-	X
	34	-	-	X	-	X
	35	-	X	X	-	X*
	36	-	X	X*	-	X*
	37	-	X	X*	-	X
	38	X	X	-	X	X
	39	X	X	-	X	X*
	40	X	X*	-	X	X*
	41	X	X*	-	X	X*
	42	X	X*	-	X	-
	43	X	-	-	X	-
	44	X	-	-	X*	-
	45	X*	-	-	X*	-

Wheel diameter	28 inch		
CS-C7000 number of teeth	30	27	24
Chaining number of teeth	30	-	-
	31	-	X
	32	-	X
	33	-	X

Wheel diameter	28 inch		
CS-C7000 number of teeth	30	27	24
34	-	-	X
35	-	X	X*
36	-	X	X*
37	-	X	-
38	X	X	-
39	X	X*	-
40	X	X*	-
41	X	-	-
42	X	-	-
43	X	-	-
44	X*	-	-
45	X*	-	-

*Not usable with coaster brake type.

-: Not usable

- In order to maintain proper performance, it is recommended that you lubricate the internal unit once a year from the start of use (or once about every 2,000 km if the bicycle is used very frequently). If the bicycle is used under harsh conditions, more frequent maintenance is required.

Also, for carrying out maintenance, the use of SHIMANO internal geared hub grease or a lubrication kit is recommended. If SHIMANO grease or a SHIMANO lubrication kit is not used, problems such as a malfunction in the shifting unit may occur.

- If the wheel becomes stiff and difficult to turn, perform an inspection.
- The gears should be periodically washed with a neutral detergent then lubricated. In addition, cleaning the chain with a neutral detergent and lubricating it can be an effective way of extending the life of the gears and chain.
- If the chain keeps coming off the gears during use, replace the sprockets and chain.
- If using a chain tensioner, use the special CS-S500 18T or 20T sprocket with chain guard. Do not use any other types of sprocket, otherwise the chain may come off the sprockets.

< **SG-S7001-11** >

- When you perform oil maintenance, use the SG-S700 OIL or TL-S703 maintenance kit.

When you replace the oil, follow the manual for TL-S703. When you replace the seal on the right side, use TL-S704. If SG-S700 OIL is not used, problems such as an oil leakage and shifting unit malfunction may occur.

< **CT-S500 / CT-S510** >

- Clean the chain tensioner periodically and lubricate all moving parts and pulleys.
- If there is a large amount of excess play in the pulleys and an abnormal amount of noise is generated while riding, replace the pulleys.
- Do not disassemble the pulley unit.
- If the tension applied is too strong, noise may be generated while riding.

- If the chain becomes elongated and excessive looseness occurs, readjust the chain tension.

< CT-S510 >









Supported hubs	Applicable sprockets	Supported rear dropout thickness	Supported rear dropout shape
8-speed hub	16-23T	4 - 9 mm	Vertical

- This product is for single front chainrings only.
- Coaster brake type
 - If the wheel becomes stiff and difficult to turn, replace the brake shoes or lubricate with grease.
 - Use only the specified grease for the brake shoes and when using a lubrication kit, remove the brake shoes to avoid contact with the oil.

The actual product may differ from the illustration because this manual is intended mainly to explain the procedures for using the product.

List of tools to be used

The following tools are needed for installation/removal, adjustment, and maintenance purposes.

Tool	
	Adjustable wrench
	Hexalobular [#25]
	Cross head screwdriver [#1]
	10 mm spanner
	2 mm hexagon wrench
	3 mm hexagon wrench
	TL-LR10
	TL-S700-B
	TL-CJ40

Installation/removal

Installing the sprocket (without chain guard)

1. Install the right-hand dust cap, then secure the sprocket with the snap ring.

Check the type, and note the orientation of the right-hand dust cap and sprocket when installing them.

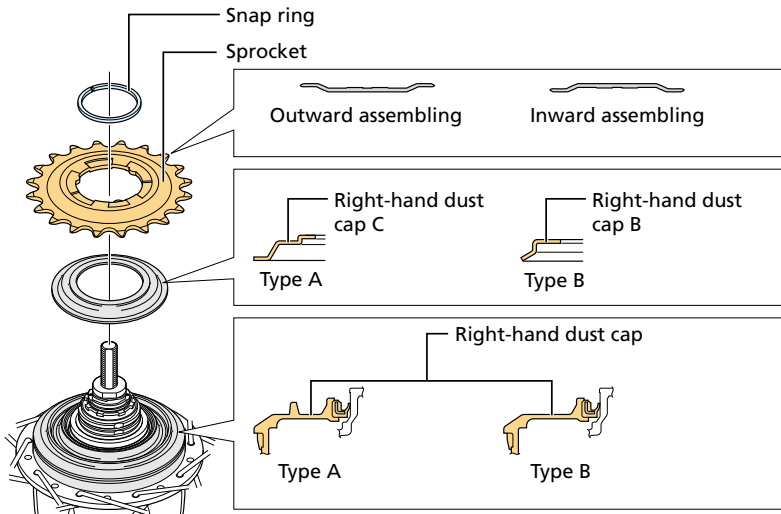

NOTICE

- Note the orientation of the sprocket and right-hand dust cap.

Type	Applicable sprockets	
	Outward assembling	Inward assembling
A	16-23T	20-23T
B	16-23T	
INTER-5E	24T, 27T, 30T	24T, 27T, 30T

Type A

If the sprocket is an inward assembling sprocket with 19T or fewer or for belt drive type, right-hand dust cap A will come into contact with the chain or pulley so type B should be used instead.

Type B

If the sprocket is an inward assembling sprocket with 16T and 3 mm teeth or for belt drive type, remove right-hand dust cap B before use.

Installing the sprocket (with chain guard)

1. Install the chain guard and right-hand dust cap.

Note the orientation of the right-hand dust cap when installing it.

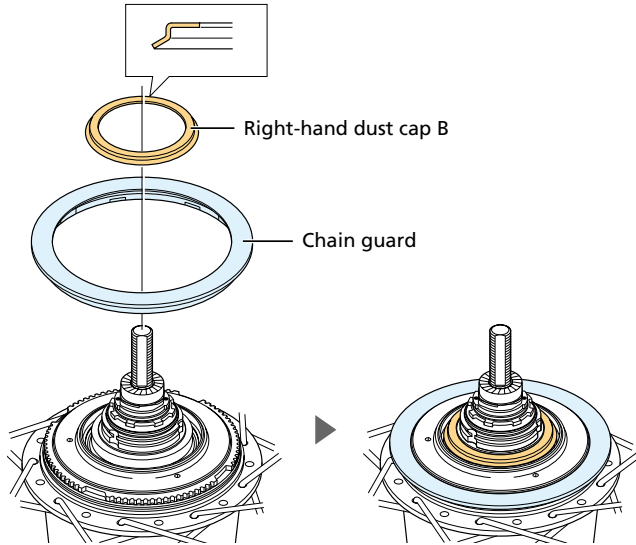

2. Install the sprocket with the guard plate facing outward, and secure it in place with the snap ring.

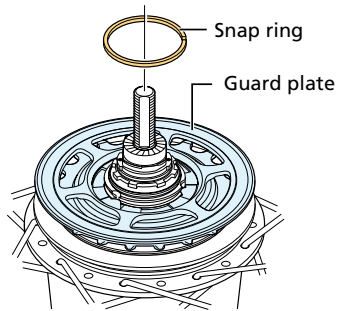

Installation of the cassette joint to the hub

1. Install the driver cap.

Note the orientation of the driver cap.

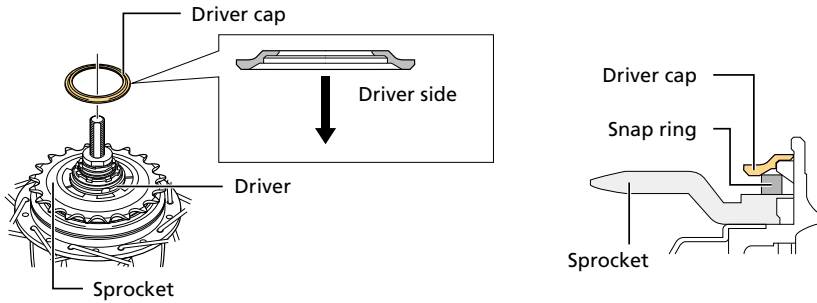

2. Turn the pulley to align the mark (red or yellow) of the cassette joint, and install to the hub body.

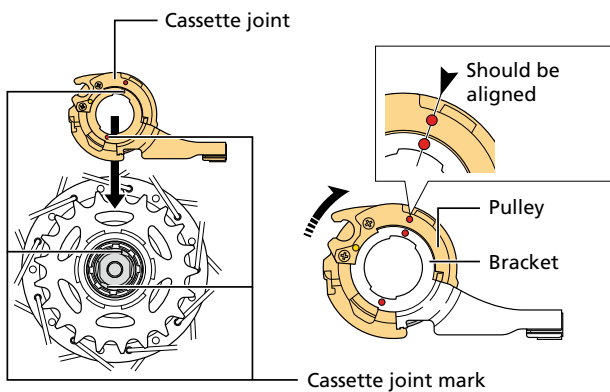

3. Turn the cassette joint mounting ring 45° clockwise to secure it.

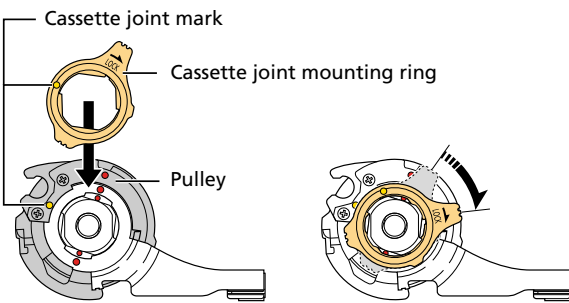

NOTICE

- Hold down the cassette joint bracket securely when performing work.

Installing the disc brake rotor

⚠ CAUTION

- Wear gloves when handling the disc brake rotor. Failure to do so may result in cuts to your hands.

CENTER LOCK type

1. Secure the disc brake rotor as shown in the figure.

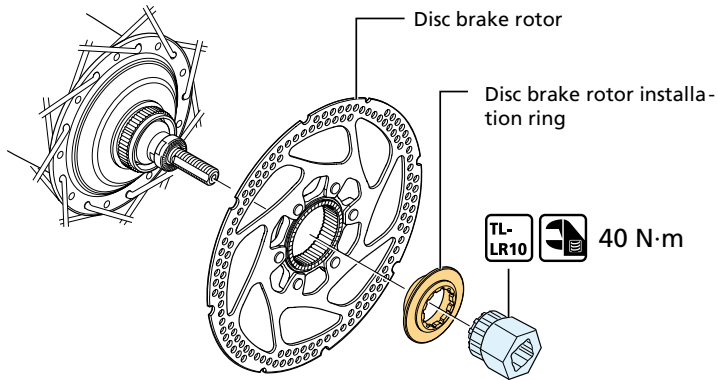

5 screw type (with lock washers)

1. Temporarily secure the disc brake rotor and the disc brake rotor lock washers to the hub as shown in the figure.

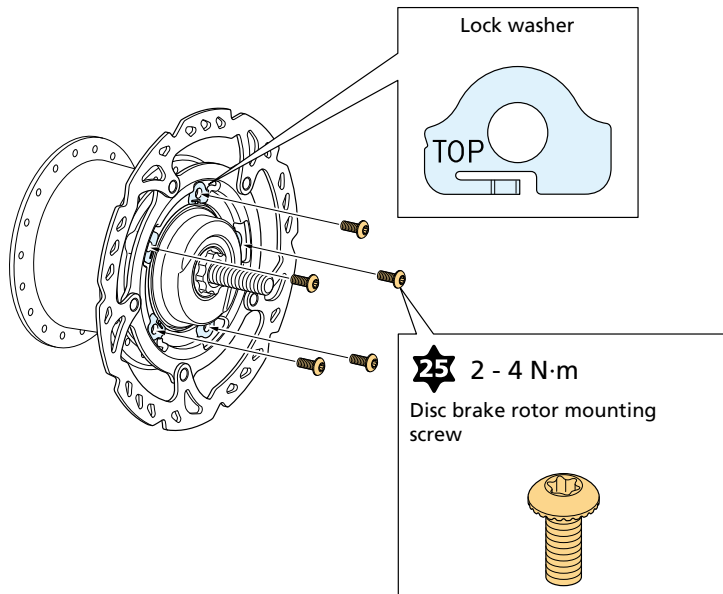

NOTICE

- Fit the lock washers so that the marking "TOP" is visible.

- Ensure that the hooked part of the lock washer is securely caught on the notch in the disc brake rotor, then tighten on the lock washer with the disc brake rotor mounting screw. If tightened while the hooked parts are against the surface of the disc brake rotor, the lock washers and its hooked parts will become deformed.

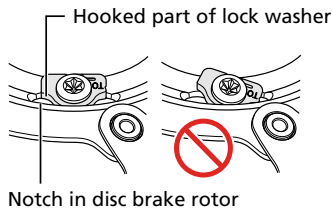

- The lock washers are not reusable. Always use new lock washers when installing the disc brake rotor.
- Use the dedicated disc brake rotor mounting screws.

2. Secure the disc brake rotor with force applied in the clockwise direction.

Tighten the disc brake rotor mounting screws in the order shown in the figure.

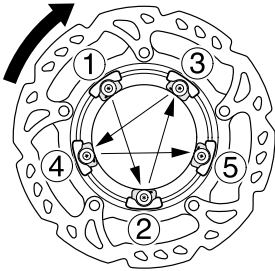

Installing the INTER M brake to the hub body

1. Engage the splines on the hub body with the splines on the INTER M brake, then temporarily tighten with the brake unit fixing nut or the brake unit fixing washer.

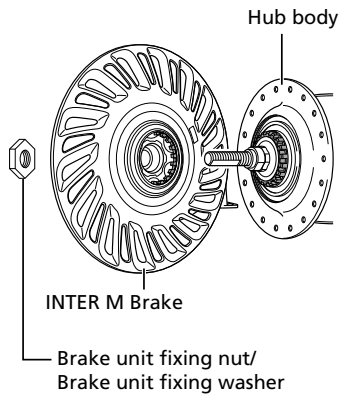

Installation of the hub to the frame

1. Mount the chain on the sprocket, then set the hub axle into the rear dropout.

When not using chain tensioner

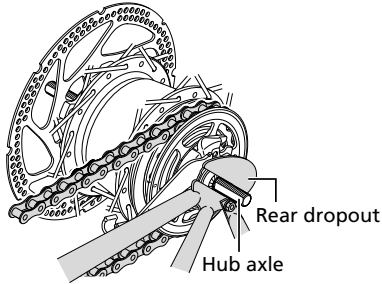

When using chain tensioner

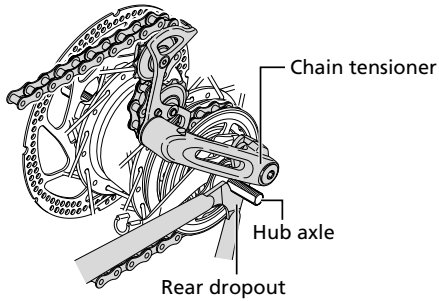

TECH TIPS

- When using the chain tensioner, be sure to read the attached instruction manual for the CT-S500 chain tensioner.

2. Place non-turn washers onto the right and left of the hub axle.

Turn the cassette joint so that the protrusions of the non-turn washers fit into the grooves in the rear dropouts and align the joint to be installed almost parallel to the chainstay.

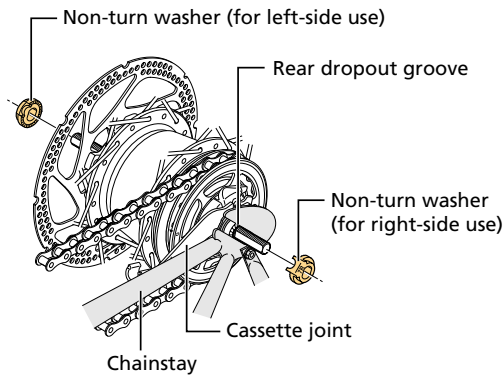

NOTICE

- When installing parts such as a mudguard stay to the hub axle, install them in the order shown in the figure.

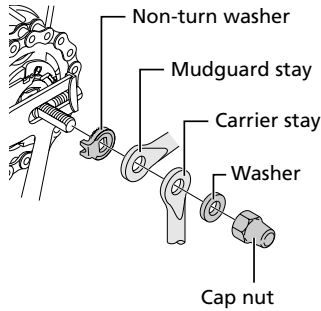

- When installing the hub to the frame, the chain guard may come off. Make sure that the chain guard is securely installed. If not properly installed, noise may be generated.

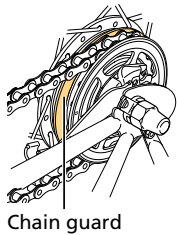

TECH TIPS

- Use a non-turn washer that matches the shape of the rear dropout. Different non-turn washers are used for the left and right sides.

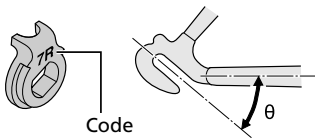

Rear dropout	Non-turn washer		
	Mark / Color		Size
	Right type	Left type	
Standard	5R / Yellow	5L / Brown	$\theta \leq 20^\circ$
	7R / Black	7L / Gray	$20^\circ \leq \theta \leq 38^\circ$
	9R / Light green	9L / Light brown	
Reversed	6R / Silver	6L / White	$\theta = 0^\circ$
Reversed (full chain case)	5R / Yellow	5L / Brown	$\theta = 0^\circ$
Vertical	8R / Blue	8L / Green	$\theta = 60^\circ - 90^\circ$

* Vertical: Does not include the coaster type.

- If the hub nuts are cap nuts, use a frame with rear dropouts that are at least 7 mm thick.

3. Secure with the cap nut.

In the case of INTER M brake type (brake unit fixing washer)

- (1) Check that the INTER M brake is securely installed with the brake unit fixing washer.
- (2) Attach the brake arm to the chainstay with the arm clip.
- (3) Temporarily fix the clip bolt and clip nut by lightly tightening them.
- (4) Take up slack in the chain and secure the wheel to the frame with the cap nut.
- (5) Attach the brake arm with the arm clip.
- (6) Securely install with the cap nut.

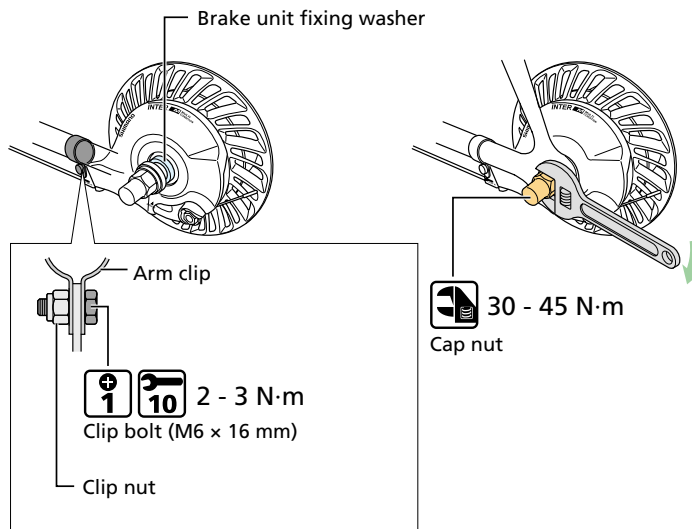

In the case of INTER M brake type (brake unit fixing nut)

- (1) Attach the brake arm to the chainstay with the arm clip.
- (2) Temporarily fix the clip bolt and clip nut by lightly tightening them.
- (3) Take up slack in the chain, align the wheel with the frame center, and temporarily secure it with the cap nut.
- (4) Slightly loosen the cap nut, and fully tighten the brake unit fixing nut.
- (5) Take up slack in the chain, align the wheel with the frame center, and secure it with the cap nut.
- (6) Attach the brake arm with the arm clip.

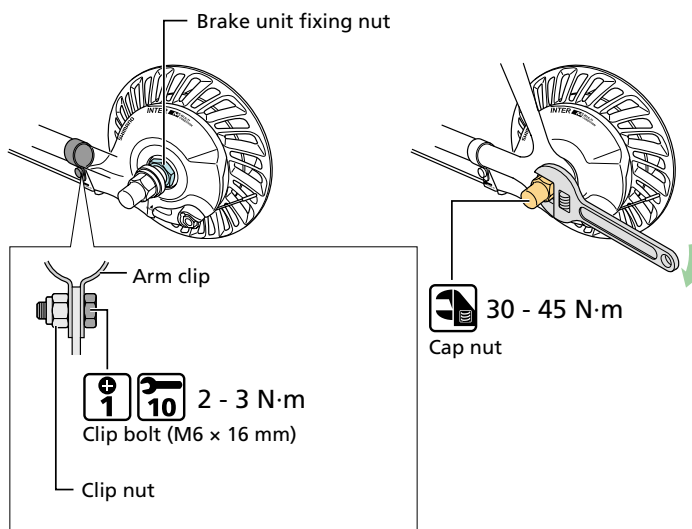

In the case of coaster brake type

- (1) Secure the brake arm with the arm clip.
- (2) Take up slack in the chain and firmly secure the wheel to the frame with the cap nut.

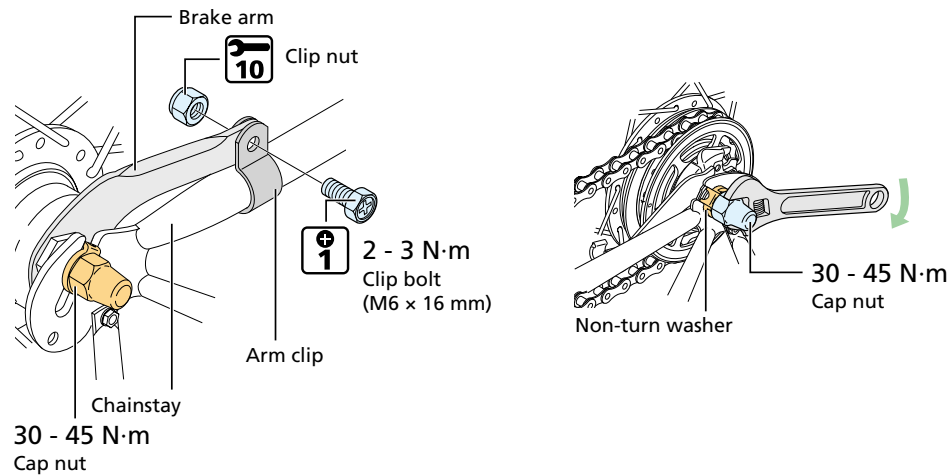

WARNING

- When securing the brake arm to the frame, be sure to use an arm clip that matches the size of the chainstay, and securely tighten them with the clip bolt and clip nut to the specified tightening torque. Use a lock nut with nylon insert (self-locking nut) as the clip nut. It is recommended that SHIMANO made clip bolts, clip nuts, and arm clips be used.
- If the clip nut comes off the brake arm, or if the clip bolt or arm clip becomes damaged, the brake arm may rotate on the chainstay and cause the handlebars to jerk suddenly, or the bicycle wheel may lock and result in serious injury due to a fall or collision.

NOTICE

- If it is not installed correctly, braking performance will suffer. Be very careful when installing it.
- If excessive force is applied to the brake arm to secure it, a problem such as noise will occur and the wheel will become difficult to turn.
- After installing the arm clip, check that the clip bolt protrudes approximately 2 - 3 mm from the end face of the clip nut.

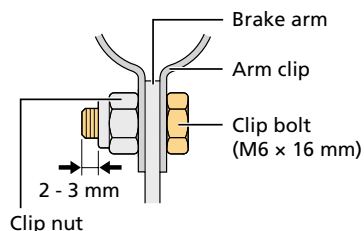

Before using the bicycle, check that the brake works properly and that the wheel turns smoothly.

Installation of the shifting cable

Shift lever side

1. Install the inner cable and outer casing aligned with the shift lever.

Refer to the dealer's manual of the shift lever for details.

NOTICE

- Make sure that the sealed outer cap is at the shift lever end.

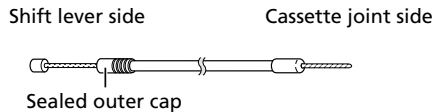

Cassette joint side

1. Operate the shift lever and set to the specified gear position.

SG-S7001 (internal 11-speed): 11-speed

SG-S7001 (internal 8-speed): 8-speed

SG-C6001 / SG-C6011 (internal 8-speed): 1-speed

SG-C7000 / SG-C7002 (internal 5-speed): 5-speed

2. Install the rubber cover and rubber bellows to the outer casing holder body.

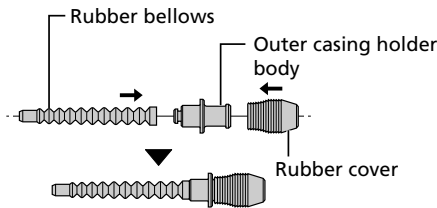

TECH TIPS

- This operation is not required if there is no rubber cover or rubber bellows.

3. Pass the inner cable through.

- (1) Wipe away any grease which may be on the inner cable and, while holding the end of the rubber bellows, pass the inner cable through.
- (2) Insert the outer casing into the rubber cover and set it into the outer casing holder body. Push the outer casing so that it securely touches the outer casing holder body.

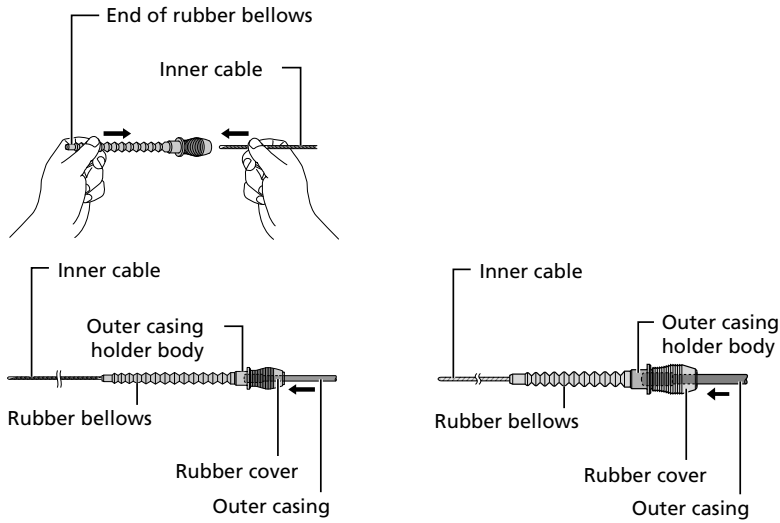

NOTICE

- Use a new inner cable; do not use a cable which has had its end cut off. Pay attention to the end of the inner cable.



4. Install the inner cable fixing bolt unit.

After checking that the end of the outer casing is securely set in the cable adjustment barrel of the shift lever, secure the unit at the specified length while pulling the inner cable.

SG-S7001 (internal 11-speed): 184 mm

SG-S7001 (internal 8-speed): 145 mm

SG-C6001 / SG-C6011 (internal 8-speed): 101 mm

SG-C7000 / SG-C7002 (internal 5-speed): 145 mm

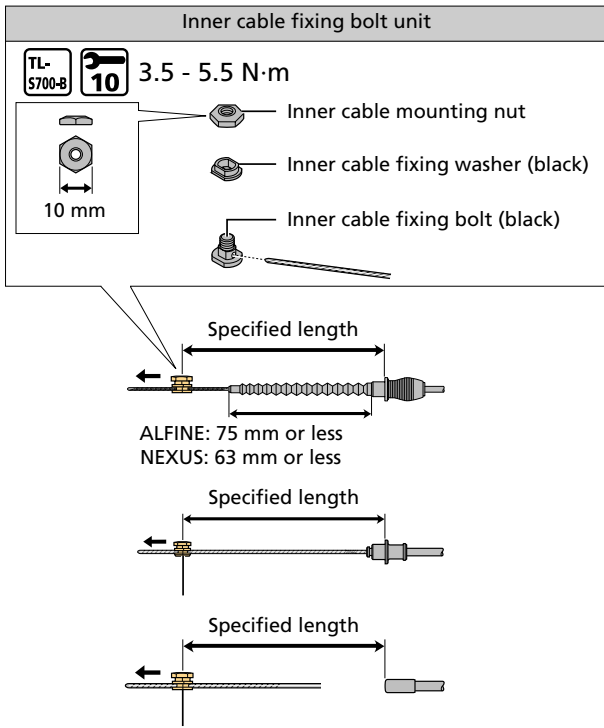

NOTICE

- Use the special inner cable fixing bolt unit.

TECH TIPS

- When installing the inner cable fixing bolt unit, use the setting tool TL-S700-B / TL-CJ40.

TL-S700-B (145 mm / 184 mm)

TL-CJ40 (101 mm / 127 mm)

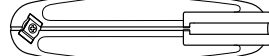
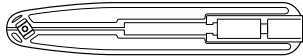

5. Set the inner cable fixing bolt unit.

- (1) Fit the inner cable fixing bolt unit into the notch in the pulley.
- (2) Turn the cable 60° clockwise or counterclockwise and attach it to the hook.

Installation/removal Installation of the shifting cable

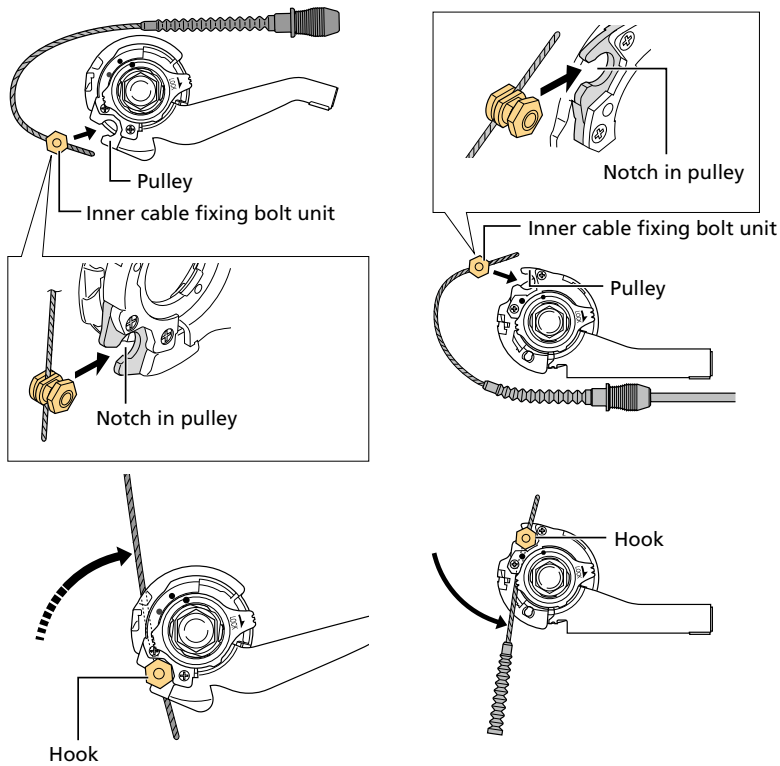

TECH TIPS

- Some models enable the outer casing holder of the cassette joint to be installed first by turning the pulley of the cassette joint.

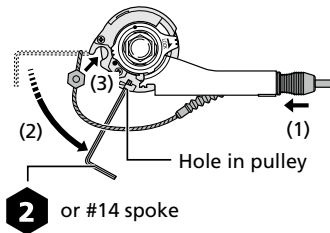

6. Set the inner cable and outer casing.

Set the inner cable in the pulley as shown in the figure, insert the inner cable into the slit in the cassette joint bracket, then securely set the outer casing holder into the outer casing holder section of the cassette joint.

Installation/removal
Installation of the shifting cable

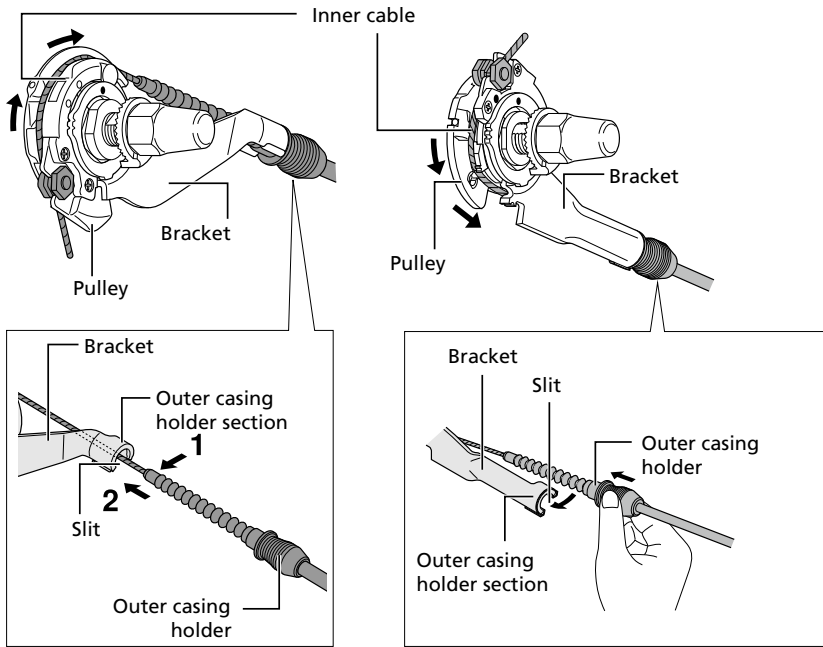

NOTICE

- Check that the inner cable is correctly seated inside the pulley guide.

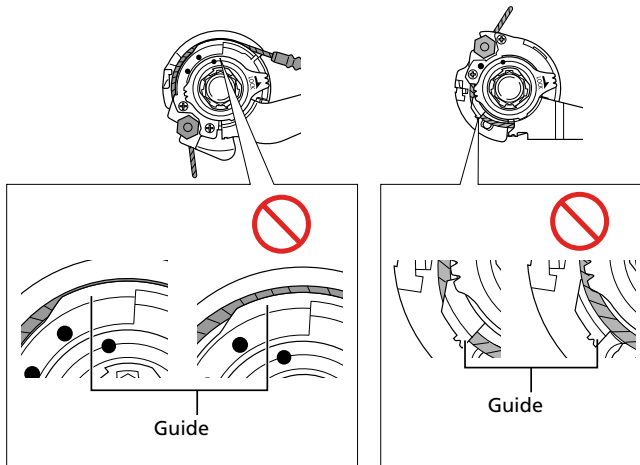

7. Secure the cable to the frame with the outer casing bands.

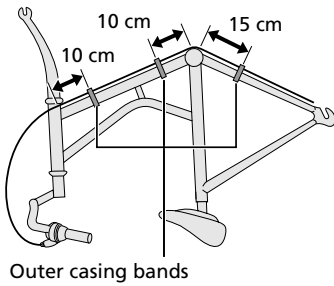

Adjustment

Adjusting the cassette joint

1. Operate the shift lever and set to the specified gear position.

SG-S7001 (internal 11-speed): 11-speed to 6-speed

SG-S7001 (internal 8-speed): 8-speed to 4-speed

SG-C6001 / SG-C6011 (internal 8-speed): 1-speed to 4-speed

SG-C7000 / SG-C7002 (internal 5-speed): 5-speed to 3-speed

2. Turn the cable adjustment barrel and align the setting lines.

Check that the yellow setting lines on the cassette joint bracket and pulley are aligned with each other. The yellow setting lines on the cassette joint are located in two places.

When the bicycle is upright

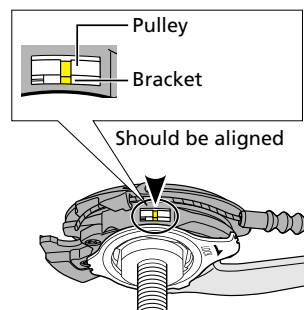

When the bicycle is upside down

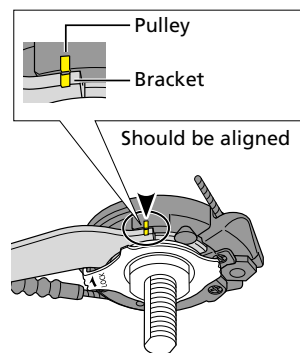

NOTICE

- If the area of the pulley and bracket marked by the setting line overlap by two thirds or less, the gears may not be properly engaged during pedaling, resulting in abnormal noise or free spinning of the pedals.

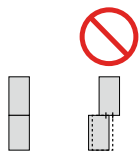

3. Operate the shift lever and recheck that the yellow setting lines are aligned.

Operate the shift lever again from step [1](#) to check.

4. Cut off the excess length of inner cable, then install the inner end cap.

For 11-speed, after installing the inner end cap, slightly bend the inner cable outward (towards the rear dropout) so that it does not touch the chain.

Adjustment

Adjusting the cassette joint

11-speed

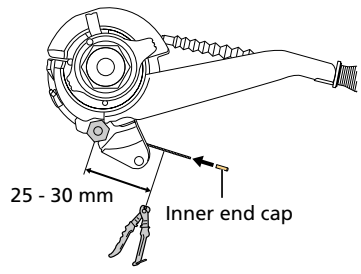

8-speed

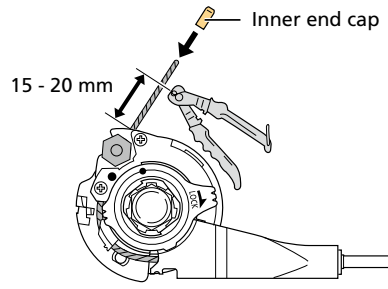

5-speed

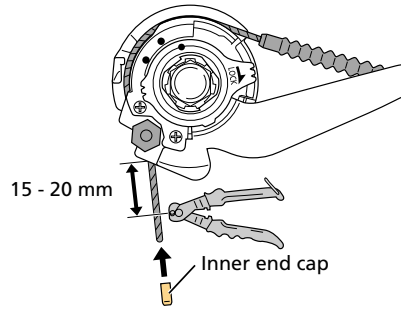

Maintenance

Disconnecting the shifting cable when removing the rear wheel from the frame

1. Set the shift lever to the specified gear.

SG-S7001 (internal 11-speed): 11-speed

SG-S7001 (internal 8-speed): 8-speed

SG-C6001 / SG-C6011 (internal 8-speed): 1-speed

SG-C7000 / SG-C7002 (internal 5-speed): 5-speed

2. Pull the outer casing holder out from the outer casing holder section.

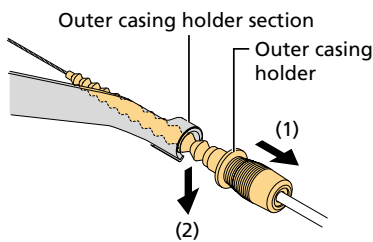

3. Remove the inner cable from the pulley guide, and remove the inner cable fixing bolt unit.

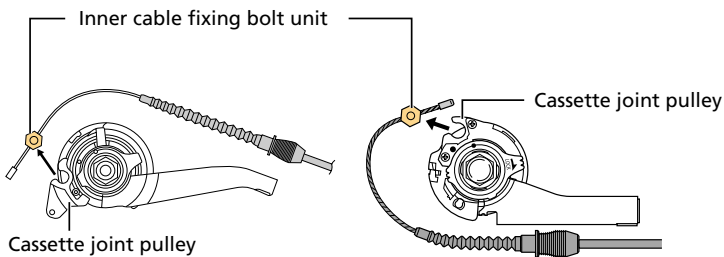

TECH TIPS

- If it is difficult to remove the shifting cable, some models enable the outer casing holder to be pulled out from the outer casing holder section of the cassette joint by turning the pulley of the cassette joint.

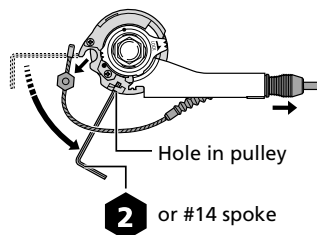

Oil maintenance of the internal assembly

For internal 8-speed (oil maintenance kit: Y00298010)

In order to maintain proper performance, it is recommended that you lubricate the internal unit once a year from the start of use (or once about every 2,000 km if the bicycle is used very frequently). If the bicycle is used under harsh conditions, more frequent maintenance is required.

Also, for carrying out maintenance, the use of SHIMANO internal geared hub grease or a lubrication kit is recommended. If SHIMANO grease or a SHIMANO lubrication kit is not used, problems such as a malfunction in the shifting unit may occur.

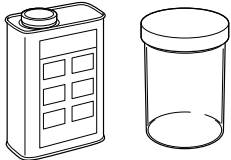

WB maintenance oil set
(Y00298010)

1. Fill the container with maintenance oil to a height of 95 mm.

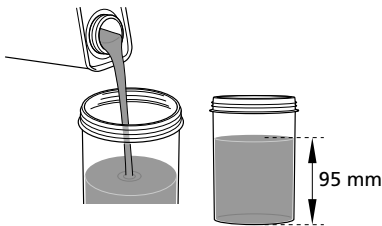

2. Immerse the internal unit in the oil from the left side of the hub until the oil reaches up to ring gear unit 1, as shown in the figure.

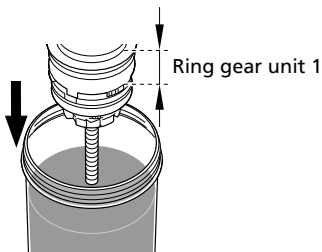

3. Keep the internal unit immersed in oil for approximately 90 seconds.

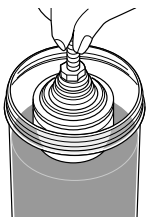

4. Remove the internal unit from the oil.

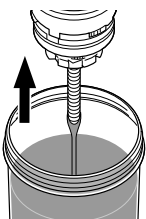

5. Let excess oil drain off for approximately 60 seconds.

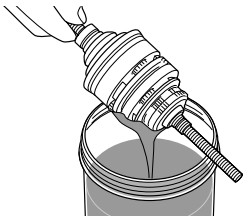

TECH TIPS

<About maintenance oil>

- Maintenance oil is reusable.
Replenish as needed.
- Store it with the lid closed after usage.

NOTICE

- After oil maintenance, it is recommended that you apply Grease (Y04130100) to the ball retainers, snap ring, brake shoe, and pinion gears.

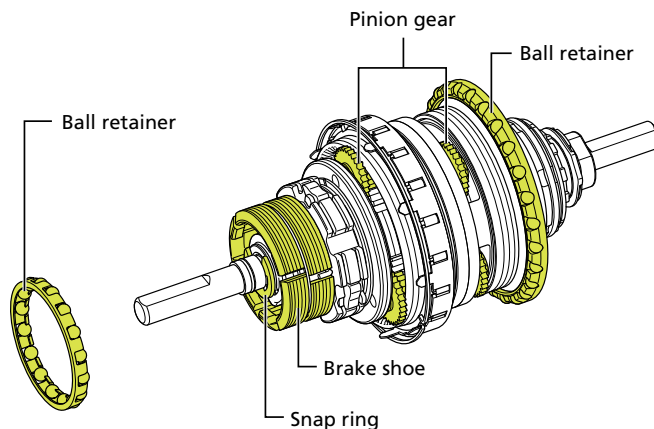

The illustration shows an example.

6. Reassemble the hub.

- (1) Use the left-hand cone (or the stop nut for the coaster brake type) to adjust the hub so that the hub shell rotates smoothly and there is no excess play in the hub axle.
Ensure that the side of the stop nut without a protrusion is facing up.
- (2) Tighten the left-hand lock nut.
The tightening torque of the left-hand lock nut depends on the type.
 - For the disc brake, roller brake, or V brake type: 24.5 to 29.4 N·m
 - For the coaster brake or coaster brake (with disc brake) type: 17.7 to 24.5 N·m

In the case of roller brake type

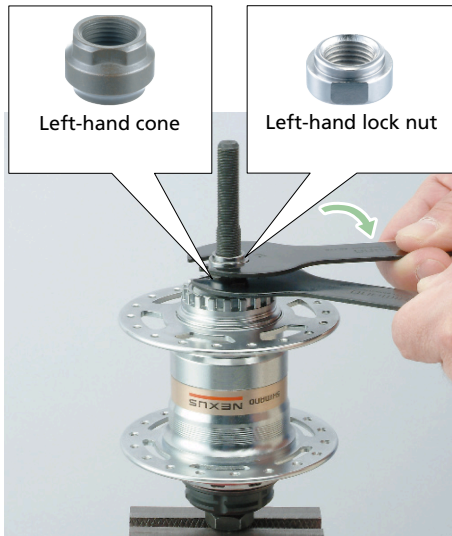

In the case of coaster brake type



The image shows an example.

For internal 11-speed (oil maintenance kit: Y13098023)

Content of kit: syringe, tube, bleed nipple, O-ring, container

Important safety information

⚠ WARNING

- When replacing the oil, be careful that no oil gets on the disc brake rotor, pads, on the rim when using rim brakes, etc. If oil gets on any of these parts, there is a danger that brake performance may be reduced. Take care of this problem according to the procedures in the brake instruction manual.

Since there is a risk of explosion or fire, do not smoke, eat, or drink while using this oil. In addition, keep it away from ignition sources such as heat, sparks, open flames, or high temperatures and prevent it from catching fire due to static electricity sparks or other sparks.

- Use only outdoors or in a well-ventilated area. Inhalation of oil mist or vapors may cause nausea. Be careful to provide ventilation and use a respirator type mask. If mist or vapor is inhaled, go immediately to an area with fresh air. Cover up with a blanket. Stay warm and stable and seek professional medical advice.

Cautions regarding handling of SG-S700 OIL

- Use appropriate eye protection when handling, and avoid contact with eyes. In the event of eye contact, flush with fresh water and seek medical assistance immediately. Contact with eyes may result in irritation.
- Use gloves when handling. In the event of skin contact, wash well with soapy water. Contact with skin may cause a rash and discomfort.
- Do not drink. If it is drunk by mistake, do not induce vomiting; make the affected person drink 1 to 2 cups of water and seek medical assistance immediately. If the affected person loses consciousness, do not give the person anything by their mouth. If vomiting occurs naturally, tilt the body to prevent inhalation.
- After use, be sure to wash hands thoroughly.
- Keep the container sealed to prevent foreign objects and moisture from getting inside, and store it in a cool, dark area away from direct sunlight.
- Keep out of reach of children.
- Dispose of used oil, old oil, or oil used for cleaning in accordance with the method stipulated by the law.
- In order to maintain proper performance, it is recommended that you replace the oil once a year from the start of use (or once about every 2,000 km if the bicycle is used very frequently).
- Do not use oil other than SG-S700 OIL. Problems such as an oil leakage and gear shifting malfunction may occur.
- Disposal of used oil: Follow local county and/or state codes for disposal. Use caution when preparing the oil for disposal.
- Read this manual carefully, and keep it in a safe place for later reference.
- For the latest product safety data sheets, check the website <https://si.shimano.com>.

TECH TIPS

- When using a 1L can of oil, it may become impossible to suck out oil with a syringe when there is only a little oil left. First, transfer all oil to a different container.

Before maintenance

Use a stand, etc., to enable the rear wheel to turn while performing work.

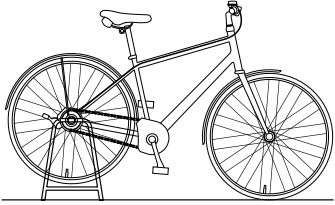

Removing the old oil

1. Rotate the wheel slowly until the oil port is facing up.

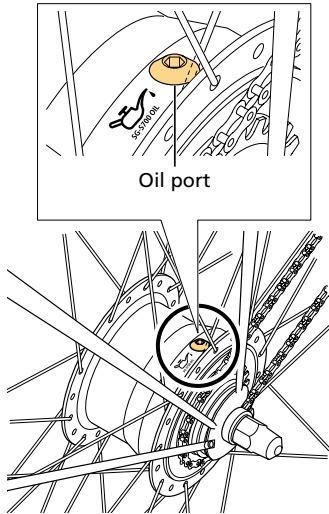

2. Remove the oil port screw and O-ring.

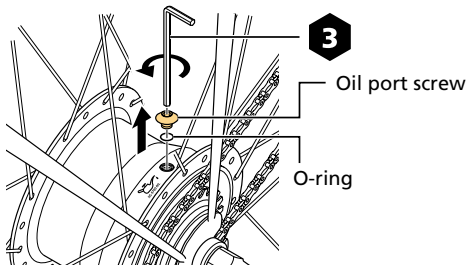

NOTICE

- Be careful that the oil port is facing up; if the oil port screw is loosened when it is not facing up, the oil inside may leak out.

3. Attach the bleed nipple with tube to the hub shell.

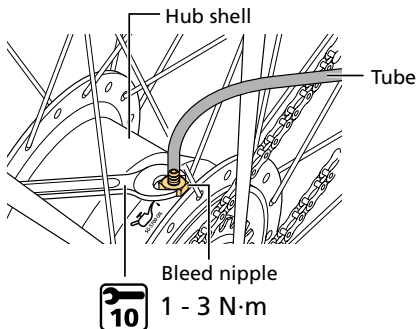

TECH TIPS

- Check that the O-ring is properly installed on the bleed nipple.

4. With the piston of the syringe pushed fully in, firmly connect the syringe to the tube.

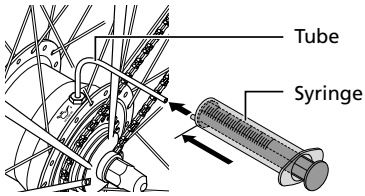

5. Insert the syringe between the spokes, and slowly turn the wheel forward until the oil port is facing down. Wait about 5 minutes with the hub kept still and not turning so that the oil settles.

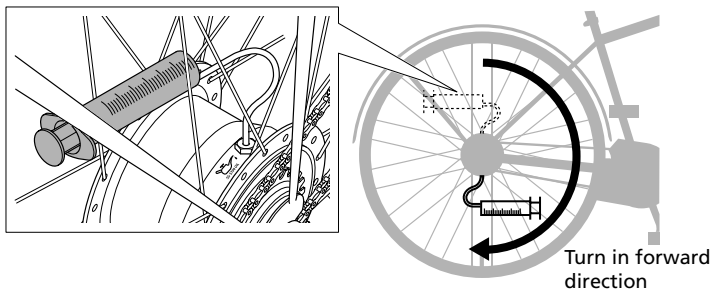

6. Pull the piston out slowly to draw out the oil inside the hub shell.

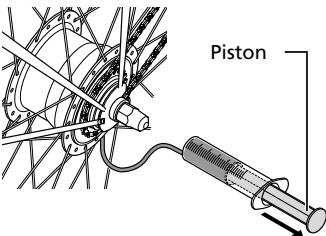

NOTICE

- If the piston is pulled out quickly, air is likely to be mixed in.

7. Rotate the wheel slowly until the oil port is facing up.

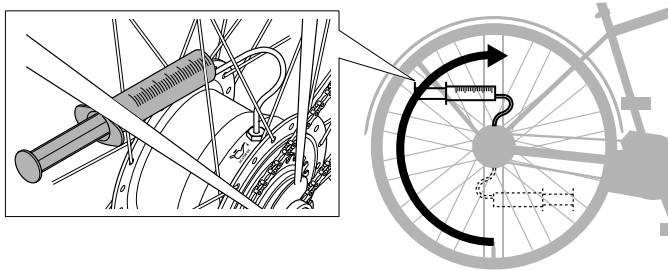

NOTICE

- To make sure that the syringe does not get caught by the chain case, etc., store the syringe between the spokes when turning the wheel.

8. While being careful that the tube does not come off the syringe, remove the bleed nipple.

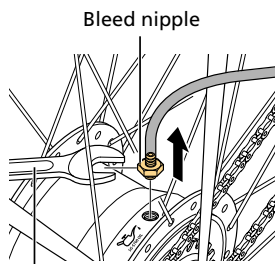

9. Remove the old oil from the syringe.

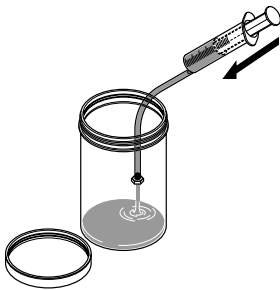

Internal cleaning

1. Attach the bleed nipple to the hub shell.

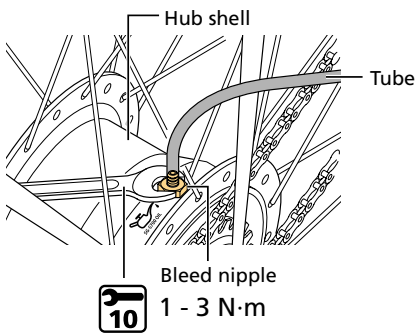

2. Suck 25 ml of new oil into the syringe and connect it firmly to the tube.

TECH TIPS

- If the syringe or tube becomes dirty when removing old oil or cleaning the inside of the hub, clean the syringe and tube using parts cleaner, etc., if necessary.

3. Push the piston to inject the new oil into the inside of the hub.

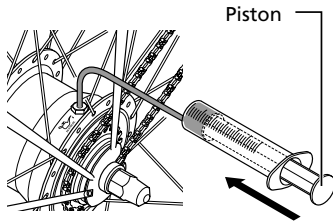

TECH TIPS

- When the oil is forced in, the internal pressure will increase and the piston may push back. If the piston is periodically pulled back to reduce the pressure inside the hub, the oil will be easier to inject into the inside of the hub.

4. After pulling back the piston to reduce the internal pressure, remove the bleed nipple.

TECH TIPS

- If the bleed nipple is removed without pulling back the piston, the oil may flow back together with air due to the internal pressure and spill out.

5. Install the O-ring and the oil port screw.

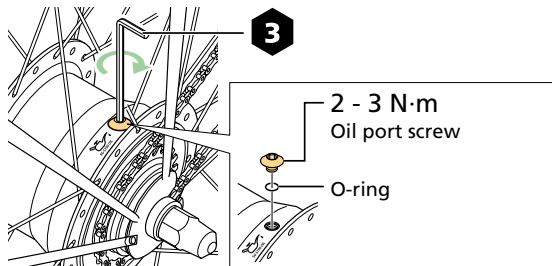

6. While performing gear shifting operations, turn the pedals to turn the wheel for approximately one minute.
7. Keep the wheel still without rotating for about 1 minute.
8. Remove the oil from inside by following procedure for removing the old oil above.

Adding new oil

1. Inject 25 ml of new oil into the hub by following steps [1](#) - [5](#) of internal cleaning.
2. Clean off any oil that may have gotten on the hub, etc.

SHIMANO

SHIMANO NORTH AMERICA BICYCLE, INC.
One Holland, Irvine, California 92618, U.S.A. Phone: +1-949-951-5003

SHIMANO EUROPE B.V.
High Tech Campus 92, 5656 AG Eindhoven, The Netherlands Phone: +31-402-612222

SHIMANO INC.
3-77 Oimatsu-cho, Sakai-ku, Sakai City, Osaka 590-8577, Japan

Please note: specifications are subject to change for improvement without notice. (English)
© Jun. 2024 by SHIMANO INC. ITP