

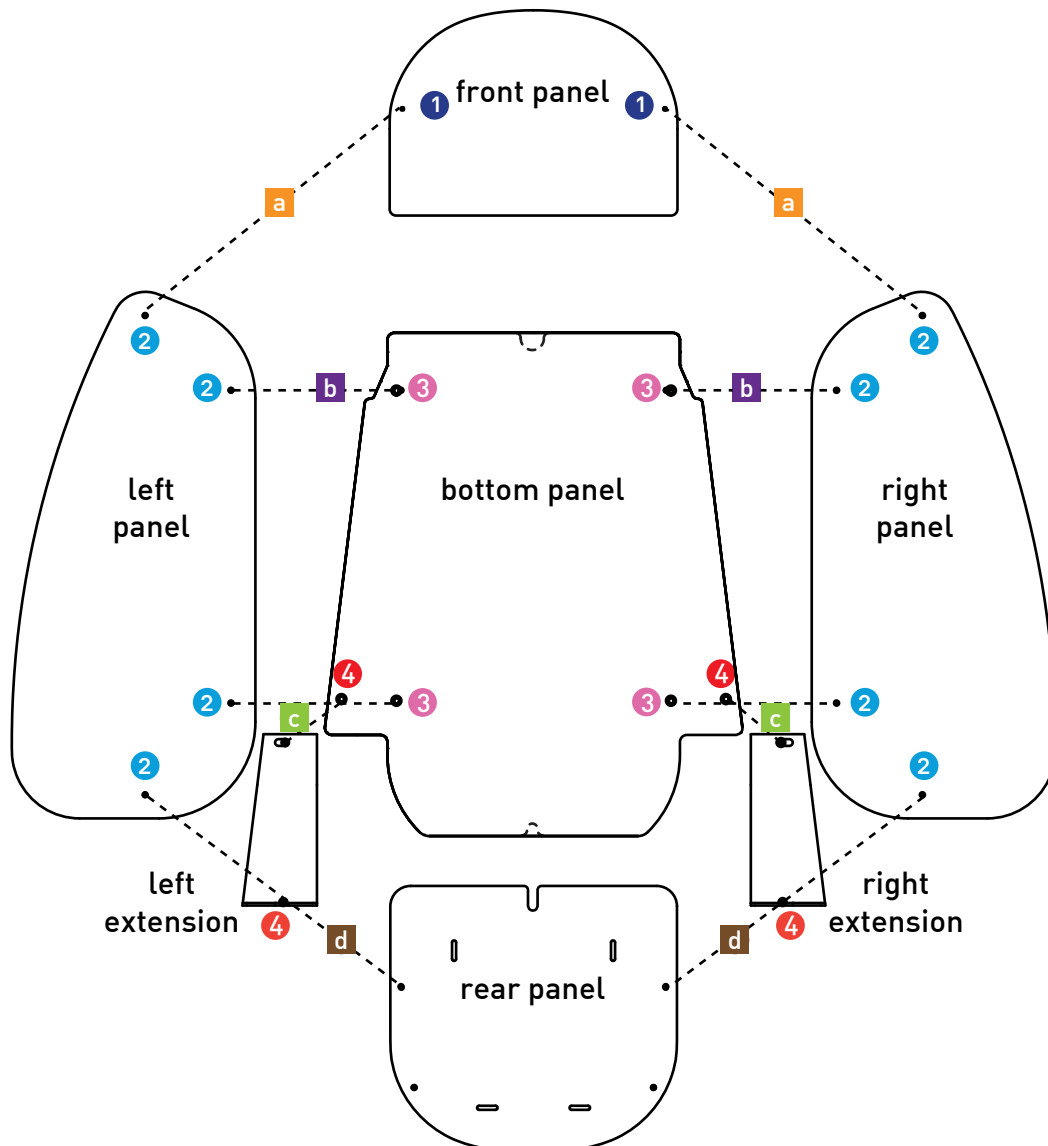

TRIOBIKE

CARGO & CARGO BIG 2 KIDS KIT INSTALLATION MANUAL

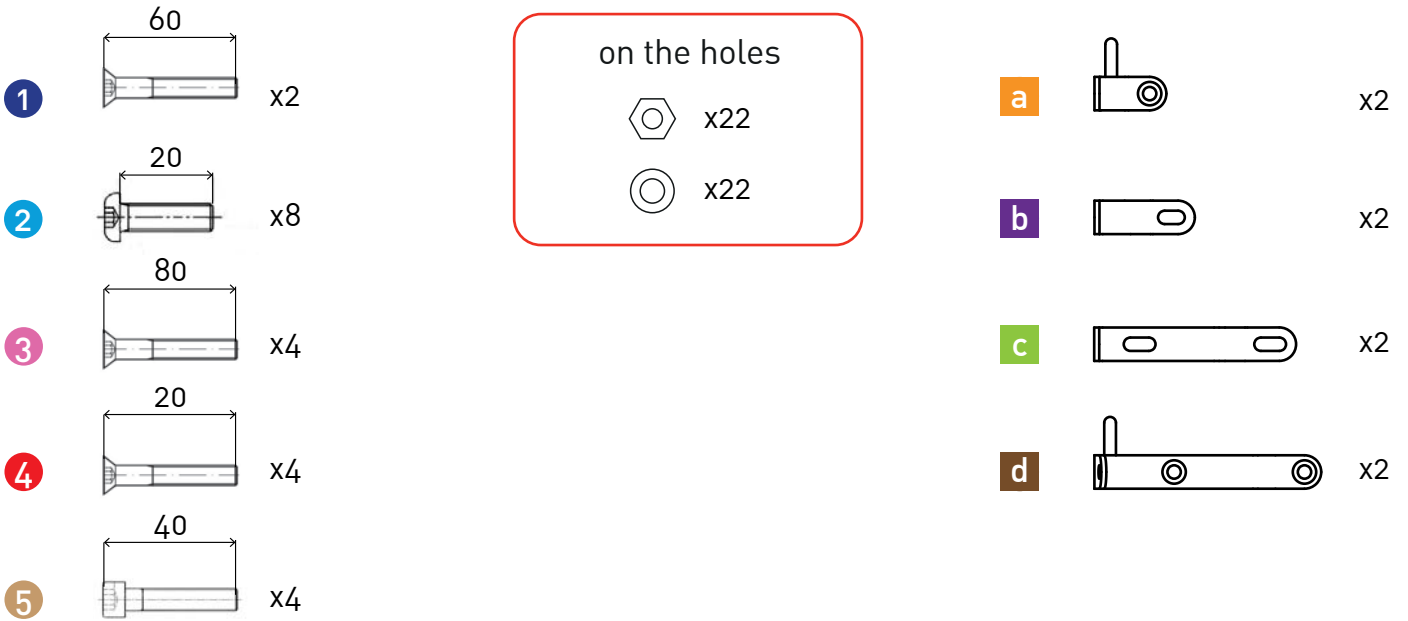

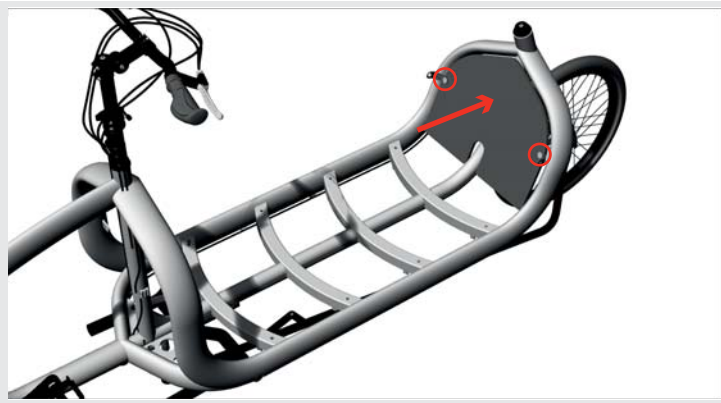

1. Place and fix the front panel and the "a" brackets using bolts #1 + washers + nuts on the back side. The brackets have to stay on top of the panel.

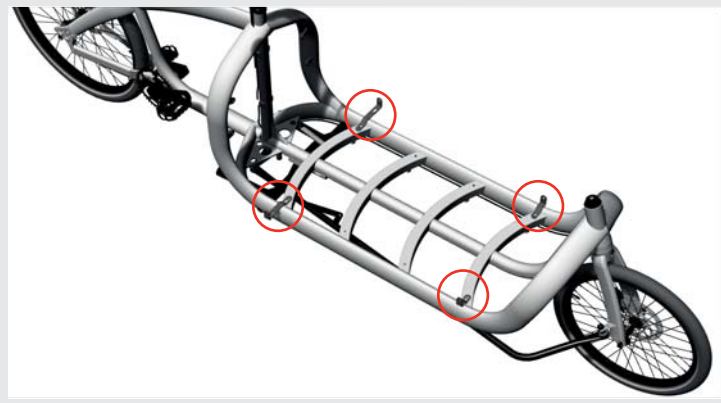

2. Place the brackets "b" and "c" on the frame, then put the bottom panel over them. The frame, panel and brackets holes have to match. Fix everything using bolts #3 + nuts and washers on the back side.

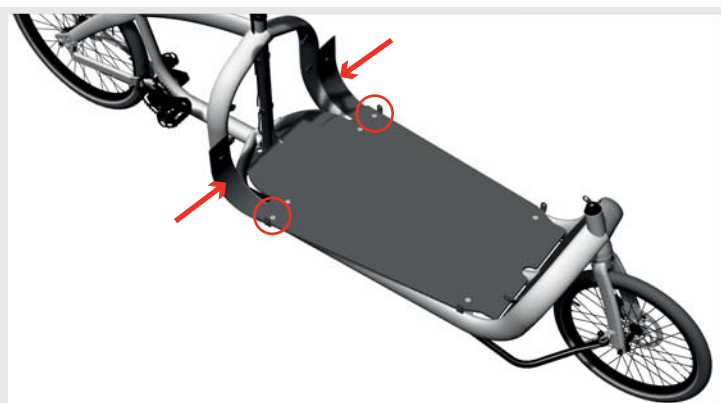

3. Place the extension panels as shown in the picture. Fix them on the bottom of the external hole of brackets "c" with bolts #4 + nuts and washers.

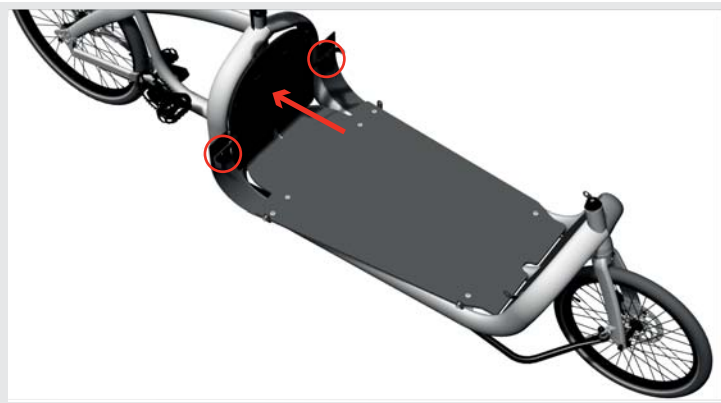

4. Place the rear panel and brackets "d" as shown in the picture, and fix them on the extension panels using bolts #4 + washers + nuts. The brackets have to stay in front of the panel.

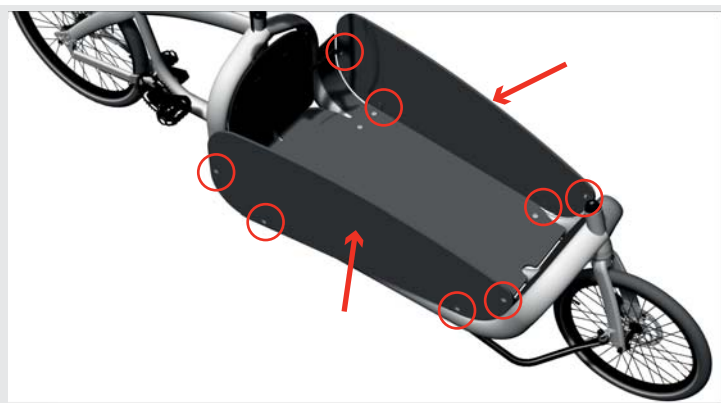

5. Mount the side panels connecting them to all the brackets using bolts #2 + washers + nuts.

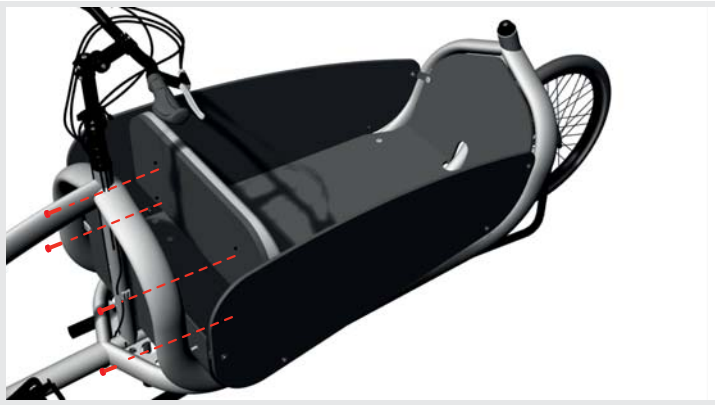

6. Mount the 2 kids seat backrest using 4 bolts #5: from the rear, insert the bolts in the threaded holes placed on the back of the backrest.



7. Once placed correctly, the backrest should stay on its position.



9. Place 2x Velcro stripes on the bottom panel and under the bench legs. The stripes have to be aligned with the bench legs.



10. Fix the bench pushing it towards the bottom panel.